

Data sheet

Dimensions

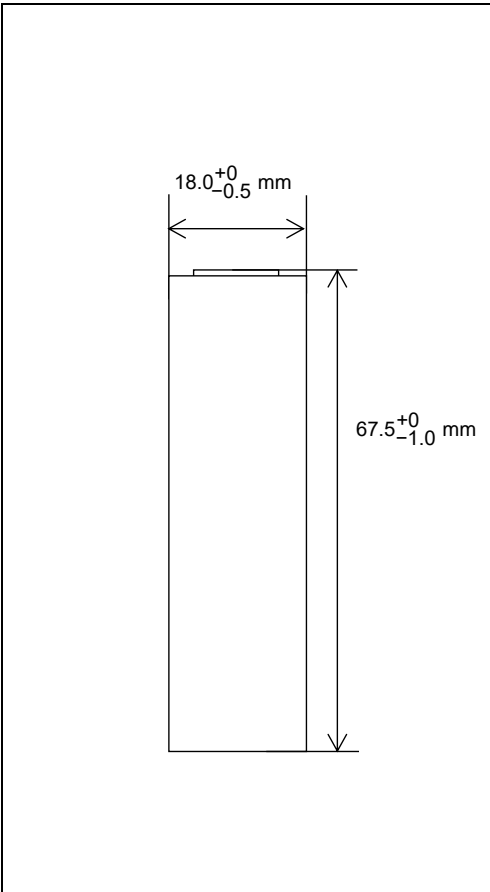

Dimensions (including tube)	Diameter	18.0 +0/ -0.5 mm
	Height	67.5 +0/ -1.0 mm
Approx. Weight (including tube)		58 g
Approx. Internal Impedance at 1kHz 20°C ₆₎		18 mΩ

6) After 3 cycles of charge and discharge under the conditions of 1), followed by the measurement 1~4 hours later.

Capacity

Nominal ₁₎	3700 mAh
Minimum ₁₎	3500 mAh

1)Single cell capacity under the following condition.

Charge : 350 mA x 16 hours, Discharge : 700 mA(E.V.=1.00 V) at 20 °C

General Specifications

Nominal Voltage		1.2 V	
End Voltage		1.00 V	
Charging Current x Time	Normal Charge	370 mA x 16 hours	
	Fast Charge ₂₎	3000 mA x about 1.3 hours	
Ambient Temp.	Charge Condition ₃₎	Normal Charge	0 °C ~ +50 °C
		Fast Charge ₂₎	0 °C ~ +40 °C
	Discharge Condition ₃₎	Recommended	0 °C ~ +50 °C
		Possible ₄₎	-20 °C ~ +85 °C
Relative Humidity ₅₎		45 % ~ 85 %	

2)Use recommended charging system.

3)Charge or discharge on outside the recommended temperature range may generate the battery degradation.

4)Only low rate discharge at low temperature.

5)No water condensation.

Storage Conditions

Ambient Temp.	Less than 30 days	-40 °C ~ +50 °C
	Less than 90 days	-40 °C ~ +40 °C
	Less than 1 year	-40 °C ~ +30 °C
Relative Humidity ₇₎		45 % ~ 85 %

7)No water condensation.

Nominal Charge Characteristics

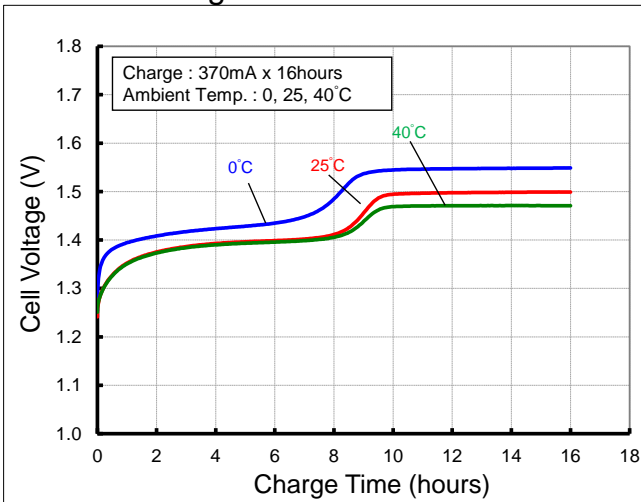

Nominal Discharge Characteristics

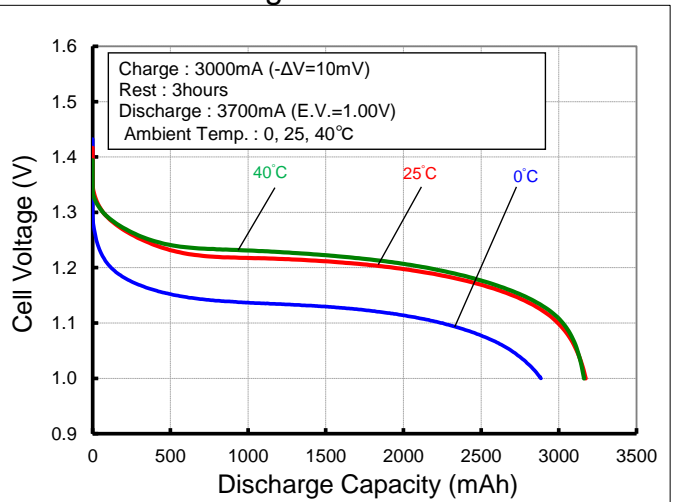

- Single cell performance and lifespan are greatly affected by usage and temperature conditions.
- Test results vary depending on individual cells.
- Each values included in this material are intended to describe performance. They are not guaranteed.